

USPC-SSS-4012-12'-4" SQR - .125"

Square Straight Steel Pole

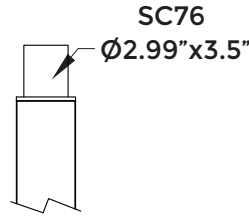

Tenon Post Top



Physical Data

Pole Height: 12'
Pole Size: 4" x 4"
Thickness: 0.125"
Weight: 83 lbs

Pole Mount Install Notes

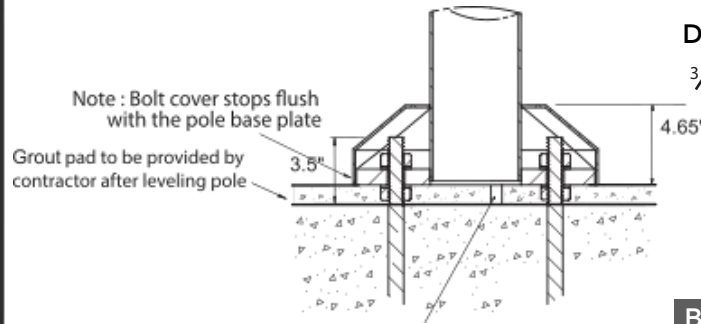

Anchor Bolt

D x L x C x T
3/4 x 18 x 4 x 6

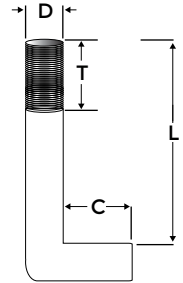

Bolt Projection

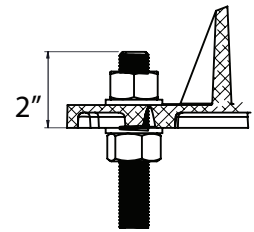

A level concrete base is poured and finished flush. This provides a uniform load displacement pad for the forces created by wind and luminaire weight

Failing to do this voids pole warranty
Foundation and Design by Others

Mounting Base

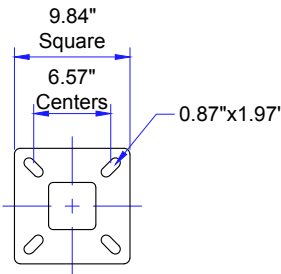

Die-Cast Base Cover



Maximum EPA

MPH	90	100	110	120	130
EPA	31.0	25.0	22.9	19.0	15.8

Not to scale template:

This drawing is being furnished for reference dimensions only and cannot be used as a template to set anchor bolts. Since it is "not to scale" Ligman accepts no responsibility for its intended use. Refer to site plans and specification before installing any anchor bolts.

• Contact Ligman Lighting USA for bolt template prior to pouring anchor bolts.

Wind Load Map

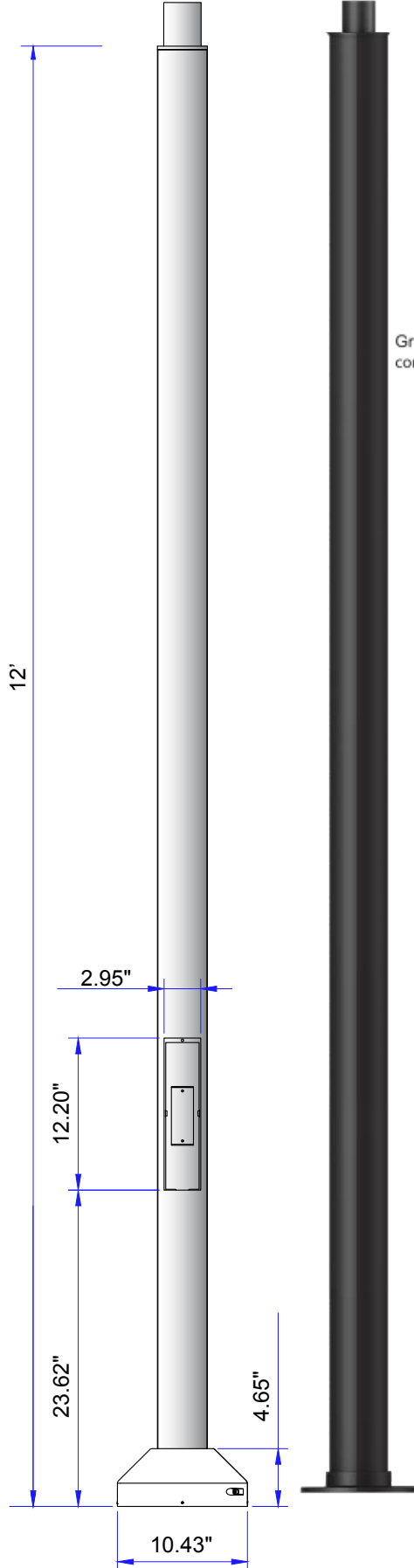

USPC-SSS-4012-12'-4" SQR - .125"

Square Straight Steel Pole



PROJECT		DATE	
QUANTITY		TYPE	
		NOTE	

ORDERING EXAMPLE || USPC-SSS-4012-12'-4" SQR .125"-SC76-02-Options

TENON	FINISH COLOR	ADDITIONAL OPTIONS - CONSULT FACTORY FOR PRICING			

SC76 - 2.99" x 3.5" Tenon

- 01 - BLACK RAL 9011
- 02 - DARK GREY RAL 7043
- 03 - WHITE RAL 9003
- 04 - METALLIC SILVER RAL 9006
- 05 - MATTE SILVER RAL 9006
- 06 - BRONZE RAL 6014
- 07 - CUSTOM RAL

- SBA - Single Banner Arm
- DBA - Double Banner Arm
- GFCI - GFCI Box
- 1LS - 1.5mm [1/16"] Leveling Shim [Enter Quantity]
- 3LS - 3mm [1/8"] Leveling Shim [Enter Quantity]
- CSA - CSA Approved for Canada -MUST SPECIFY-

INSPIRED BY NATURE FINISHES

- SW01 - OAK FINISH
- SW02 - WALNUT FINISH
- SW03 - PINE FINISH
- DF - DOUGLAS FIR FINISH
- CW - CHERRY WOOD FINISH
- NW - NATIONAL WALNUT FINISH
- SU01 - CONCRETE FINISH
- SU02 - SOFTSCAPE FINISH
- SU03 - STONE FINISH
- SU04 - CORTEN FINISH

THERE IS AN ADDITIONAL COST FOR THESE FINISHES



LS Leveling Shim

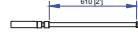

SBA Single Banner Arm



DBA Double Banner Arm

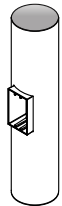

GFCI GFCI Box

Banner arms are designed with a safety break-away at the clamp with an internal safety wire that prevents the arm from falling to the ground. It is important to calculate the additional EPA loading on the pole based on the size and quantity of banners. Adding banners will affect the EPA of the pole and should be taken into consideration before installing. Incorrect pole loading of any type voids pole warranty.

Inspired by Nature Finishes

The Inspired by nature Finishing is a unique system of decorative powder coating. Our metal decoration process can easily transform the appearance of metal or aluminum product into a wood grain finish.

This patented technology enables the simulation of wood grain, and even marble or granite finish through the use of decorative powder coating.

The wood grain finish is so realistic that it's almost undistinguishable from real wood, even from a close visual inspection. The system of coating permeates the entire thickness of the coat and as a result, the coating cannot be removed by normal rubbing, chipping, or scratching.

The Coating Process

After pre-treatment the prepared parts are powder coated with a specially formulated polyurethane powder. This powder provides protection against wear, abrasion, impact and corrosion and acts as the relief base color for the finalized metal decoration.

The component is then wrapped with a sheet of non-porous film with the selected decoration pattern printed on it using special high temperature inks.

This printed film transfer is vacuum-sealed to the surface for a complete thermo print and then transferred into a customized oven. The oven transforms the ink into different forms within the paint layer before it becomes solid. Finally, the film is removed, and a vivid timber look on aluminum remains.

Wood grain coating can create beautiful wood-looking products of any sort. There are over 300 combinations of designs currently in use. Wood grains can be made with different colors, designs, etc.

Our powder coatings are certified for indoor and outdoor applications and are backed by a comprehensive warranty. These coatings rise to the highest conceivable standard of performance excellence and design innovation.

Added Benefits

- Resistance to salt-acid room, accelerated aging
- Boiling water, lime and condensed water resistant
- Anti-Graffiti, Anti-Slip, Anti-Microbial, Anti-Scratch
- Super durable (UV resistant)
- TGIC free (non-toxic)

More Custom Finishes Available Upon Request

Consult factory for pricing and lead times



Example: Inspired by Nature Finish

Anchor Bolt Installation for Poles

What's Included Per Pole



A single anchor bolt template is provided per pole size to be used for the poles on the project.

Anchor bolt template may be round or square dependant upon which pole is being used.



Use anchor bolt template to set anchor bolts into concrete as per civil engineering instructions.

Ligman does not provide foundation details. A local engineer that is familiar with the site soil conditions should provide this information.

NOTE:

Ligman does not recommend using leveling Shims for pole installations.

Leveling shims can be provided, contact Ligman for more information.

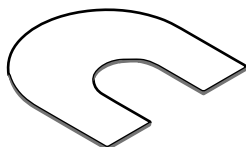

Leveling Shim Example



Ensure that the concrete is plumb using a level. Failing to do this will result in pole being uneven or tilted.

Preferred Pole Installation



Bolt Projection



Using Leveling Nuts Option A



When using leveling Nuts

After establishing a level platform the space between the original concrete surface and the pole base should be filled with concrete and finished flush.

This provides a uniform load displacement pad for the forces created by wind and luminaire weight

Foundation and Design by Others

Using Leveling Nuts Option B



When using leveling Nuts

After establishing a level platform the space between the original concrete surface and the pole base should be filled with concrete and finished flush.

This provides a uniform load displacement pad for the forces created by wind and luminaire weight